

LM78XX Series Voltage Regulators

General Description

The LM78XX series of three terminal regulators is available with several fixed output voltages making them useful in a wide range of applications. One of these is local on card regulation, eliminating the distribution problems associated with single point regulation. The voltages available allow these regulators to be used in logic systems, instrumentation, HiFi, and other solid state electronic equipment. Although designed primarily as fixed voltage regulators these devices can be used with external components to obtain adjustable voltages and currents.

The LM78XX series is available in an aluminum TO-3 package which will allow over 1.0A load current if adequate heat sinking is provided. Current limiting is included to limit the peak output current to a safe value. Safe area protection for the output transistor is provided to limit internal power dissipation. If internal power dissipation becomes too high for the heat sinking provided, the thermal shutdown circuit takes over preventing the IC from overheating.

Considerable effort was expended to make the LM78XX series of regulators easy to use and minimize the number of external components. It is not necessary to bypass the out-

put, although this does improve transient response. Input bypassing is needed only if the regulator is located far from the filter capacitor of the power supply.

For output voltage other than 5V, 12V and 15V the LM117 series provides an output voltage range from 1.2V to 57V.

Features

- Output current in excess of 1A
- Internal thermal overload protection
- No external components required
- Output transistor safe area protection
- Internal short circuit current limit
- Available in the aluminum TO-3 package

Voltage Range

LM7805C	5V
LM7812C	12V
LM7815C	15V

Connection Diagrams

**Metal Can Package
TO-3 (K)
Aluminum**

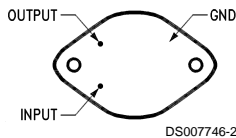

Bottom View
Order Number LM7805CK,
LM7812CK or LM7815CK
See NS Package Number KC02A

**Plastic Package
TO-220 (T)**

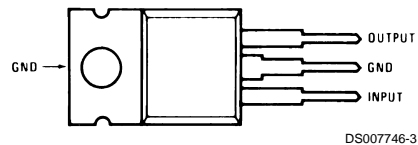

Top View
Order Number LM7805CT,
LM7812CT or LM7815CT
See NS Package Number T03B

Schematic

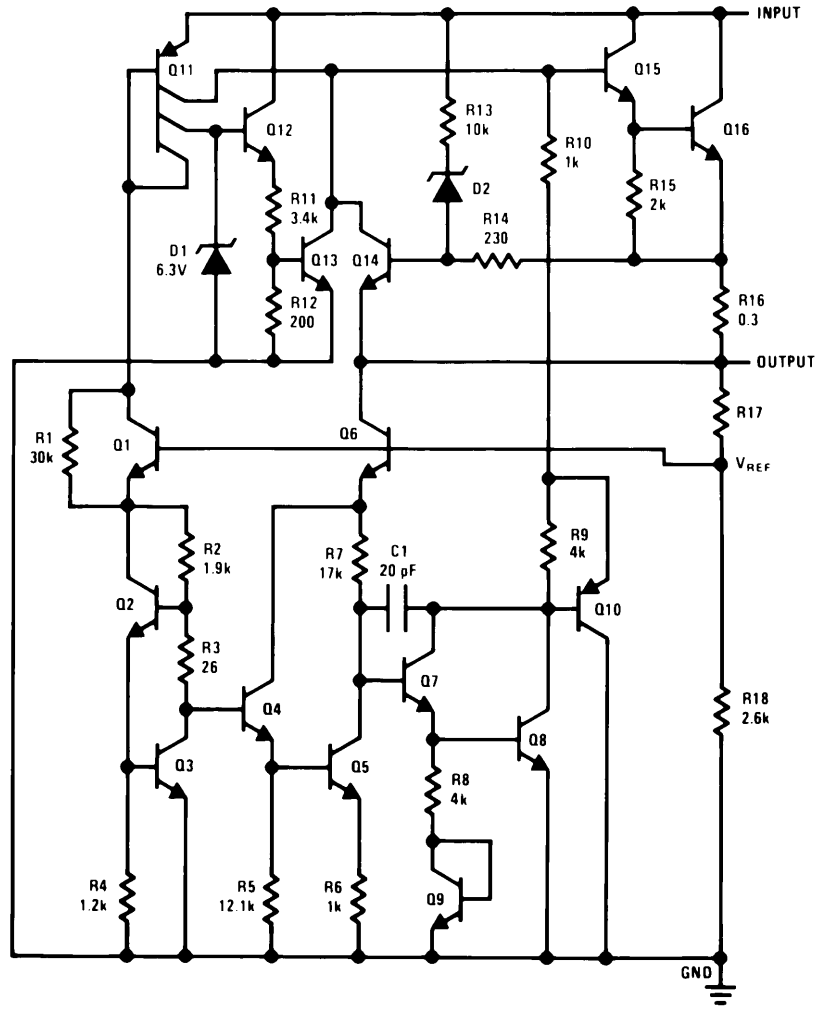

DS007746-1

Absolute Maximum Ratings (Note 3)

If Military/Aerospace specified devices are required, please contact the National Semiconductor Sales Office/Distributors for availability and specifications.

Input Voltage

 $(V_O = 5V, 12V \text{ and } 15V)$

35V

Internal Power Dissipation (Note 1)

Internally Limited

Operating Temperature Range (T_A)

0°C to +70°C

Maximum Junction Temperature

(K Package)

150°C

(T Package)

150°C

Storage Temperature Range

-65°C to +150°C

Lead Temperature (Soldering, 10 sec.)

TO-3 Package K

300°C

TO-220 Package T

230°C

Electrical Characteristics LM78XXC (Note 2)0°C ≤ T_J ≤ 125°C unless otherwise noted.

Output Voltage			5V			12V			15V			Units	
Input Voltage (unless otherwise noted)			10V			19V			23V				
Symbol	Parameter	Conditions	Min	Typ	Max	Min	Typ	Max	Min	Typ	Max		
V_O	Output Voltage	$T_J = 25^\circ\text{C}$, $5 \text{ mA} \leq I_O \leq 1 \text{ A}$	4.8	5	5.2	11.5	12	12.5	14.4	15	15.6	V	
		$P_D \leq 15\text{W}$, $5 \text{ mA} \leq I_O \leq 1 \text{ A}$	4.75		5.25	11.4		12.6	14.25		15.75	V	
		$V_{\text{MIN}} \leq V_{\text{IN}} \leq V_{\text{MAX}}$	(7.5 ≤ V_{IN} ≤ 20)			(14.5 ≤ V_{IN} ≤ 27)			(17.5 ≤ V_{IN} ≤ 30)			V	
ΔV_O	Line Regulation	$I_O = 500 \text{ mA}$	$T_J = 25^\circ\text{C}$	3 50		4 120		4 150		mV			
			ΔV_{IN}	(7 ≤ V_{IN} ≤ 25)		14.5 ≤ V_{IN} ≤ 30)		(17.5 ≤ V_{IN} ≤ 30)		V			
		0°C ≤ T_J ≤ +125°C	ΔV_{IN}		50		120		150		mV		
			(8 ≤ V_{IN} ≤ 20)		(15 ≤ V_{IN} ≤ 27)		(18.5 ≤ V_{IN} ≤ 30)		V				
		$I_O \leq 1 \text{ A}$	$T_J = 25^\circ\text{C}$	ΔV_{IN}		50		120		150		mV	
			(7.5 ≤ V_{IN} ≤ 20)		(14.6 ≤ V_{IN} ≤ 27)		(17.7 ≤ V_{IN} ≤ 30)		V				
0°C ≤ T_J ≤ +125°C	ΔV_{IN}		25		60		75		mV				
	(8 ≤ V_{IN} ≤ 12)		(16 ≤ V_{IN} ≤ 22)		(20 ≤ V_{IN} ≤ 26)		V						
ΔV_O	Load Regulation	$T_J = 25^\circ\text{C}$	$5 \text{ mA} \leq I_O \leq 1.5 \text{ A}$	10 50		12 120		12 150		mV			
			$250 \text{ mA} \leq I_O \leq 750 \text{ mA}$	25		60		75		mV			
		$5 \text{ mA} \leq I_O \leq 1 \text{ A}$, 0°C ≤ T_J ≤ +125°C	50		120		150		mV				
I_Q	Quiescent Current	$I_O \leq 1 \text{ A}$	$T_J = 25^\circ\text{C}$	8		8		8		mA			
			0°C ≤ T_J ≤ +125°C	8.5		8.5		8.5		mA			
ΔI_Q	Quiescent Current Change	$5 \text{ mA} \leq I_O \leq 1 \text{ A}$		0.5		0.5		0.5		mA			
		$T_J = 25^\circ\text{C}$, $I_O \leq 1 \text{ A}$	$V_{\text{MIN}} \leq V_{\text{IN}} \leq V_{\text{MAX}}$		1.0		1.0		1.0		mA		
			(7.5 ≤ V_{IN} ≤ 20)		(14.8 ≤ V_{IN} ≤ 27)		(17.9 ≤ V_{IN} ≤ 30)		V				
0°C ≤ T_J ≤ +125°C		$V_{\text{MIN}} \leq V_{\text{IN}} \leq V_{\text{MAX}}$		1.0		1.0		1.0		mA			
(7 ≤ V_{IN} ≤ 25)		(14.5 ≤ V_{IN} ≤ 30)		(17.5 ≤ V_{IN} ≤ 30)		V							
V_N	Output Noise Voltage	$T_A = 25^\circ\text{C}$, 10 Hz ≤ f ≤ 100 kHz		40		75		90		μV			
$\frac{\Delta V_{\text{IN}}}{\Delta V_{\text{OUT}}}$	Ripple Rejection	$f = 120 \text{ Hz}$	$I_O \leq 1 \text{ A}$, $T_J = 25^\circ\text{C}$ or $I_O \leq 500 \text{ mA}$	62 80		55 72		54 70		dB			
			0°C ≤ T_J ≤ +125°C	62		55		54		dB			
		$V_{\text{MIN}} \leq V_{\text{IN}} \leq V_{\text{MAX}}$		(8 ≤ V_{IN} ≤ 18)		(15 ≤ V_{IN} ≤ 25)		(18.5 ≤ V_{IN} ≤ 28.5)		V			
R_O	Dropout Voltage	$T_J = 25^\circ\text{C}$, $I_{\text{OUT}} = 1 \text{ A}$		2.0		2.0		2.0		V			
	Output Resistance	$f = 1 \text{ kHz}$		8		18		19		mΩ			

Electrical Characteristics LM78XXC (Note 2) (Continued)

$0^{\circ}\text{C} \leq T_J \leq 125^{\circ}\text{C}$ unless otherwise noted.

Output Voltage			5V			12V			15V			Units
Input Voltage (unless otherwise noted)			10V			19V			23V			
Symbol	Parameter	Conditions	Min	Typ	Max	Min	Typ	Max	Min	Typ	Max	
	Short-Circuit Current	$T_J = 25^{\circ}\text{C}$	2.1			1.5			1.2			A
	Peak Output Current	$T_J = 25^{\circ}\text{C}$	2.4			2.4			2.4			A
	Average TC of V_{OUT}	$0^{\circ}\text{C} \leq T_J \leq +125^{\circ}\text{C}$, $I_O = 5\text{ mA}$	0.6			1.5			1.8			mV/ $^{\circ}\text{C}$
V_{IN}	Input Voltage Required to Maintain Line Regulation	$T_J = 25^{\circ}\text{C}$, $I_O \leq 1\text{ A}$	7.5			14.6			17.7			V

Note 1: Thermal resistance of the TO-3 package (K, KC) is typically $4^{\circ}\text{C}/\text{W}$ junction to case and $35^{\circ}\text{C}/\text{W}$ case to ambient. Thermal resistance of the TO-220 package (T) is typically $4^{\circ}\text{C}/\text{W}$ junction to case and $50^{\circ}\text{C}/\text{W}$ case to ambient.

Note 2: All characteristics are measured with capacitor across the input of $0.22\ \mu\text{F}$, and a capacitor across the output of $0.1\ \mu\text{F}$. All characteristics except noise voltage and ripple rejection ratio are measured using pulse techniques ($t_w \leq 10\text{ ms}$, duty cycle $\leq 5\%$). Output voltage changes due to changes in internal temperature must be taken into account separately.

Note 3: Absolute Maximum Ratings indicate limits beyond which damage to the device may occur. For guaranteed specifications and the test conditions, see Electrical Characteristics.

Typical Performance Characteristics

Maximum Average Power Dissipation

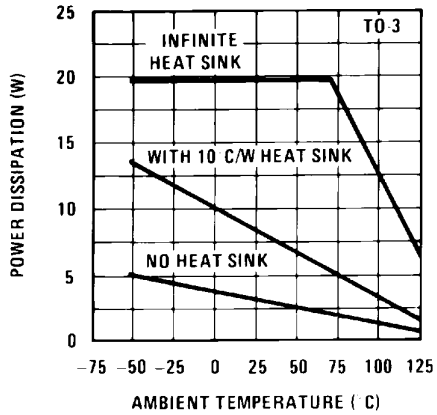

DS007746-5

Maximum Average Power Dissipation

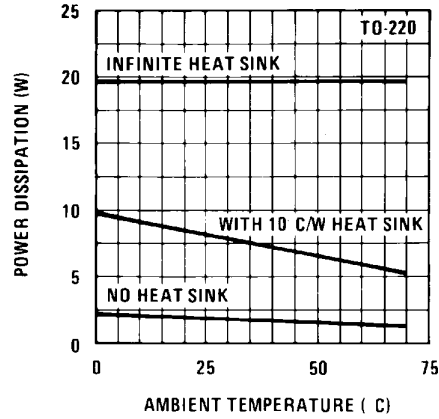

DS007746-6

Peak Output Current

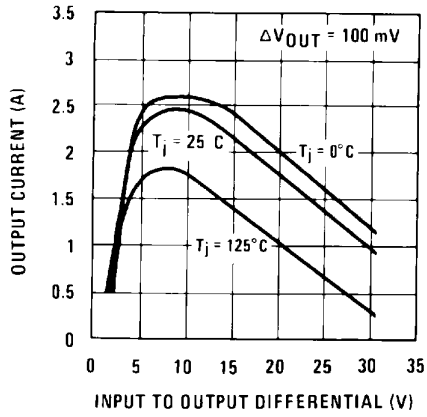

DS007746-7

Output Voltage (Normalized to 1V at Tj = 25°C)

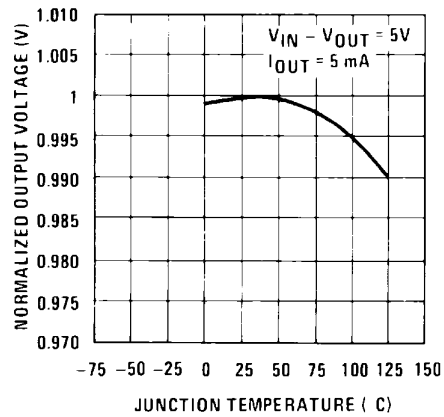

DS007746-8

Ripple Rejection

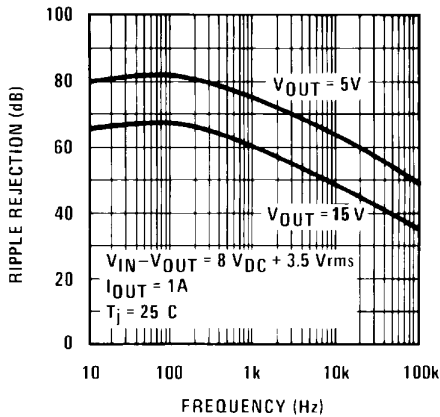

DS007746-9

Ripple Rejection

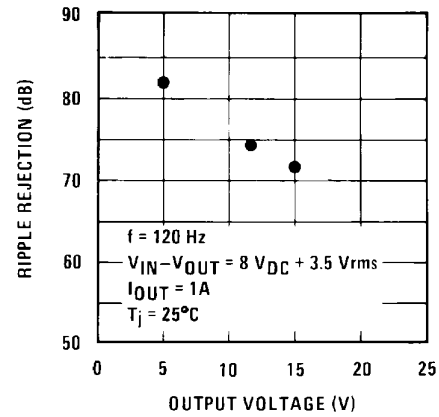

DS007746-10

Typical Performance Characteristics (Continued)

Output Impedance

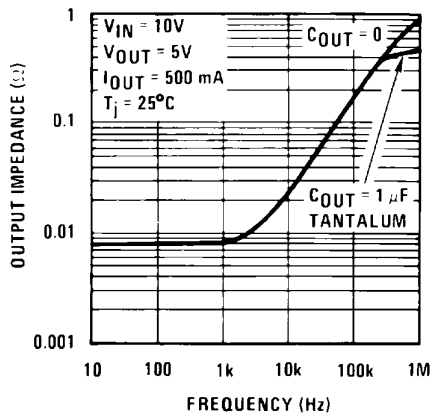

Dropout Voltage

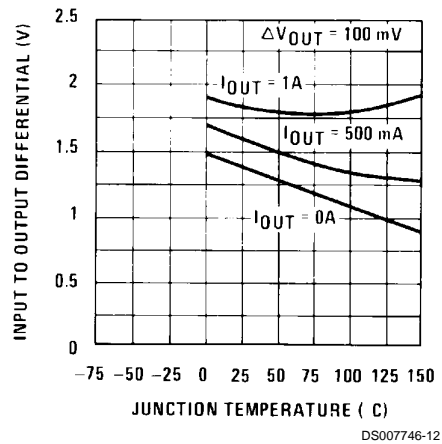

Dropout Characteristics

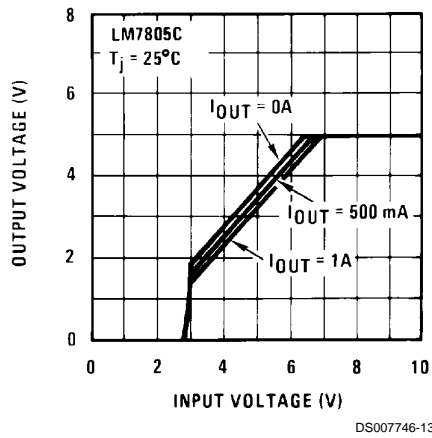

Quiescent Current

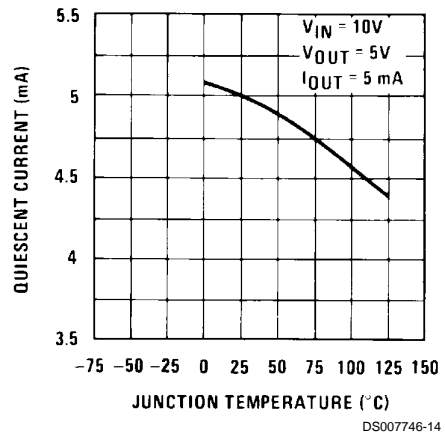

Quiescent Current

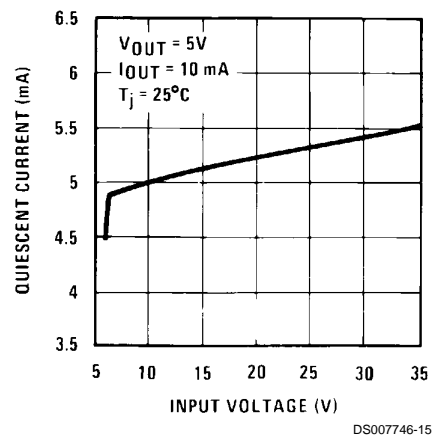

Physical Dimensions inches (millimeters) unless otherwise noted

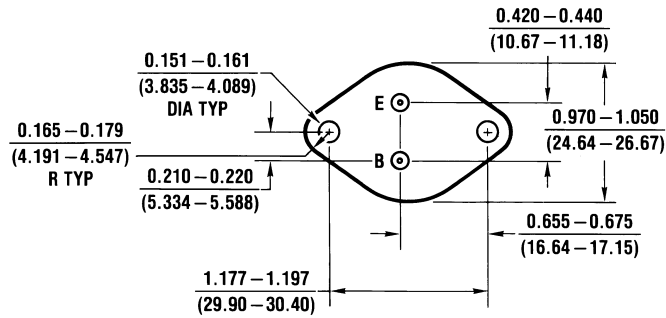
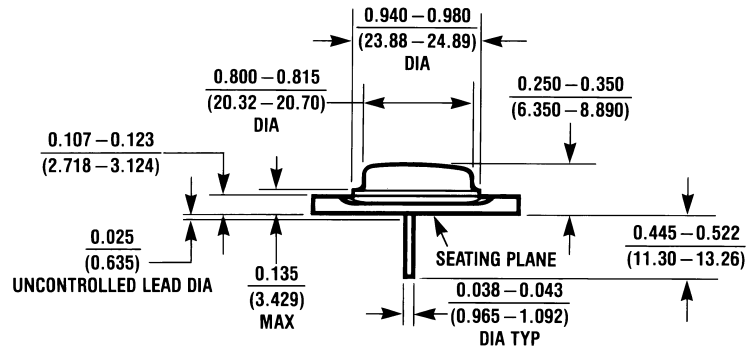

KC02A (REV C)

Aluminum Metal Can Package (KC)
Order Number LM7805CK, LM7812CK or LM7815CK
NS Package Number KC02A

Physical Dimensions inches (millimeters) unless otherwise noted (Continued)

