

Features

- High Voltage Type (20V Rating)
- Schmitt Trigger Action with No External Components
- Hysteresis Voltage (Typ.)
 - 0.9V at VDD = 5V
 - 2.3V at VDD = 10V
 - 3.5V at VDD = 15V
- Noise Immunity Greater than 50%
- No Limit on Input Rise and Fall Times
- Low VDD to VSS Current During Slow Input Ramp
- 100% Tested for Quiescent Current at 20V
- 5V, 10V and 15V Parametric Ratings
- Maximum Input Current of 1 μ A at 18V Over Full Package Temperature Range; 100nA at 18V and +25°C
- Standardized Symmetrical Output Characteristics
- Meets All Requirements of JEDEC Tentative Standard No. 13B, "Standard Specifications for Description of 'B' Series CMOS Devices"

Applications

- Wave and Pulse Shapers
- High Noise Environment Systems
- Monostable Multivibrators
- Astable Multivibrators

Description

CD40106BMS consists of six Schmitt trigger circuits. Each circuit functions as an inverter with Schmitt trigger action on the input. The trigger switches at different points for positive and negative going signals. The difference between the positive going voltage (VP) and the negative going voltage (VN) is defined as hysteresis voltage (VH) (see Figure 17).

The CD40106BMS is supplied in these 14 lead outline packages:

Braze Seal DIP	H4Q
Frit Seal DIP	H1B
Ceramic Flatpack	H3W

Pinout

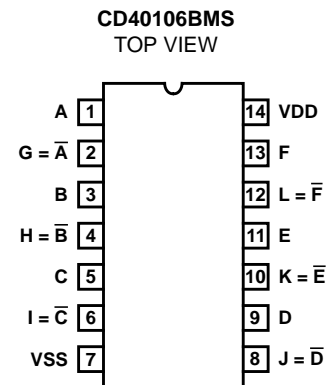

Functional Diagram

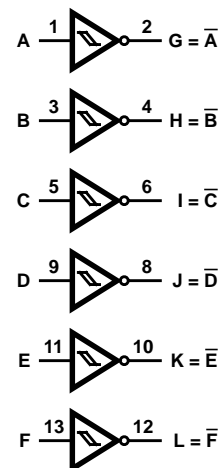

Logic Diagram

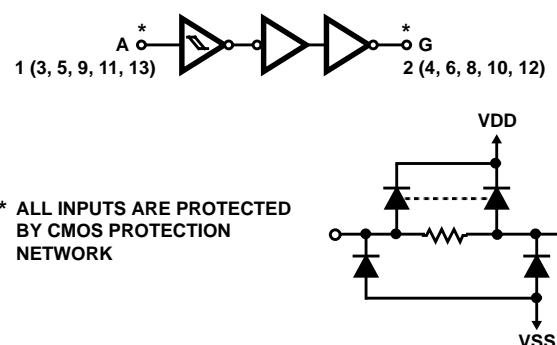

FIGURE 1. 1 OF 6 SCHMITT TRIGGERS

Specifications CD40106BMS

Absolute Maximum Ratings

DC Supply Voltage Range, (VDD)	-0.5V to +20V (Voltage Referenced to VSS Terminals)
Input Voltage Range, All Inputs	-0.5V to VDD +0.5V
DC Input Current, Any One Input	±10mA
Operating Temperature Range	-55°C to +125°C Package Types D, F, K, H
Storage Temperature Range (TSTG)	-65°C to +150°C
Lead Temperature (During Soldering)	+265°C At Distance 1/16 ± 1/32 Inch (1.59mm ± 0.79mm) from case for 10s Maximum

Reliability Information

Thermal Resistance	θ_{ja}	θ_{jc}
Ceramic DIP and FRIT Package	80°C/W	20°C/W
Flatpack Package	70°C/W	20°C/W
Maximum Package Power Dissipation (PD) at +125°C		
For $T_A = -55^\circ\text{C}$ to +100°C (Package Type D, F, K)	500mW	
For $T_A = +100^\circ\text{C}$ to +125°C (Package Type D, F, K)	Derate Linearity at 12mW/°C to 200mW	
Device Dissipation per Output Transistor	100mW	
For $T_A =$ Full Package Temperature Range (All Package Types)		
Junction Temperature	+175°C	

TABLE 1. DC ELECTRICAL PERFORMANCE CHARACTERISTICS

PARAMETER	SYMBOL	CONDITIONS (NOTE 1)		GROUP A SUBGROUPS	TEMPERATURE	LIMITS		UNITS
						MIN	MAX	
Supply Current	IDD	VDD = 20V, VIN = VDD or GND		1	+25°C	-	2	µA
				2	+125°C	-	200	µA
		VDD = 18V, VIN = VDD or GND		3	-55°C	-	2	µA
Input Leakage Current	IIL	VIN = VDD or GND	VDD = 20	1	+25°C	-100	-	nA
				2	+125°C	-1000	-	nA
				3	-55°C	-100	-	nA
Input Leakage Current	IIH	VIN = VDD or GND	VDD = 20	1	+25°C	-	100	nA
				2	+125°C	-	1000	nA
				3	-55°C	-	100	nA
Output Voltage	VOL15	VDD = 15V, No Load		1, 2, 3	+25°C, +125°C, -55°C	-	50	mV
Output Voltage	VOH15	VDD = 15V, No Load (Note 2)		1, 2, 3	+25°C, +125°C, -55°C	14.95	-	V
Output Current (Sink)	IOL5	VDD = 5V, VOUT = 0.4V		1	+25°C	0.53	-	mA
Output Current (Sink)	IOL10	VDD = 10V, VOUT = 0.5V		1	+25°C	1.4	-	mA
Output Current (Sink)	IOL15	VDD = 15V, VOUT = 1.5V		1	+25°C	3.5	-	mA
Output Current (Source)	IOH5A	VDD = 5V, VOUT = 4.6V		1	+25°C	-	-0.53	mA
Output Current (Source)	IOH5B	VDD = 5V, VOUT = 2.5V		1	+25°C	-	-1.8	mA
Output Current (Source)	IOH10	VDD = 10V, VOUT = 9.5V		1	+25°C	-	-1.4	mA
Output Current (Source)	IOH15	VDD = 15V, VOUT = 13.5V		1	+25°C	-	-3.5	mA
N Threshold Voltage	VNTH	VDD = 10V, ISS = -10µA		1	+25°C	-2.8	-0.7	V
P Threshold Voltage	VPTH	VSS = 0V, IDD = 10µA		1	+25°C	0.7	2.8	V
Functional	F	VDD = 2.8V, VIN = VDD or GND		7	+25°C	VOH > VDD/2	VOL < VDD/2	V
		VDD = 20V, VIN = VDD or GND		7	+25°C			
		VDD = 18V, VIN = VDD or GND		8A	+125°C			
		VDD = 3V, VIN = VDD or GND		8B	-55°C			
Positive Trigger Threshold Voltage (See Figure 17)	VP5	VDD = 5V		1, 2, 3	+25°C, +125°C, -55°C	2.2	3.6	V
	VP10	VDD = 10V		1, 2, 3	+25°C, +125°C, -55°C	4.6	7.1	V
	VP15	VDD = 15V		1, 2, 3	+25°C, +125°C, -55°C	6.8	10.8	V
Negative Trigger Threshold Voltage (See Figure 17)	VN5	VDD = 5V		1, 2, 3	+25°C, +125°C, -55°C	0.9	2.8	V
	VN10	VDD = 10V		1, 2, 3	+25°C, +125°C, -55°C	2.5	5.2	V
	VN15	VDD = 15V		1, 2, 3	+25°C, +125°C, -55°C	4	7.4	V
Hysteresis Voltage (See Figure 17)	VH5	VDD = 5V		1, 2, 3	+25°C, +125°C, -55°C	0.3	1.6	V
	VH10	VDD = 10V		1, 2, 3	+25°C, +125°C, -55°C	1.2	3.4	V
	VH15	VDD = 15V		1, 2, 3	+25°C, +125°C, -55°C	1.6	5.0	V

NOTES: 1. All voltages referenced to device GND, 100% testing being implemented. 2. Go/No Go test with limits applied to inputs. 3. For accuracy, voltage is measured differentially to VDD. Limit is 0.050V max.

Specifications CD40106BMS

TABLE 2. AC ELECTRICAL PERFORMANCE CHARACTERISTICS

PARAMETER	SYMBOL	CONDITIONS (NOTE 1, 2)	GROUP A SUBGROUPS	TEMPERATURE	LIMITS		UNITS
					MIN	MAX	
Propagation Delay	TPHL TPLH	VDD = 5V, VIN = VDD or GND	9	+25°C	-	280	ns
			10, 11	+125°C, -55°C	-	378	ns
Transition Time	TTHL TTLH	VDD = 5V, VIN = VDD or GND	9	+25°C	-	200	ns
			10, 11	+125°C, -55°C	-	270	ns

NOTES:

1. CL = 50pF, RL = 200K, Input TR, TF < 20ns
2. -55°C and +125°C limits guaranteed, 100% testing being implemented.

TABLE 3. ELECTRICAL PERFORMANCE CHARACTERISTICS

PARAMETER	SYMBOL	CONDITIONS	NOTES	TEMPERATURE	LIMITS		UNITS
					MIN	MAX	
Supply Current	IDD	VDD = 5V, VIN = VDD or GND	1, 2	-55°C, +25°C	-	1	µA
				+125°C	-	30	µA
		VDD = 10V, VIN = VDD or GND	1, 2	-55°C, +25°C	-	2	µA
				+125°C	-	60	µA
		VDD = 15V, VIN = VDD or GND	1, 2	-55°C, +25°C	-	2	µA
				+125°C	-	120	µA
Output Voltage	VOL	VDD = 5V, No Load	1, 2	+25°C, +125°C, -55°C	-	50	mV
Output Voltage	VOL	VDD = 10V, No Load	1, 2	+25°C, +125°C, -55°C	-	50	mV
Output Voltage	VOH	VDD = 5V, No Load	1, 2	+25°C, +125°C, -55°C	4.95	-	V
Output Voltage	VOH	VDD = 10V, No Load	1, 2	+25°C, +125°C, -55°C	9.95	-	V
Output Current (Sink)	IOL5	VDD = 5V, VOUT = 0.4V	1, 2	+125°C	0.36	-	mA
				-55°C	0.64	-	mA
Output Current (Sink)	IOL10	VDD = 10V, VOUT = 0.5V	1, 2	+125°C	0.9	-	mA
				-55°C	1.6	-	mA
Output Current (Sink)	IOL15	VDD = 15V, VOUT = 1.5V	1, 2	+125°C	2.4	-	mA
				-55°C	4.2	-	mA
Output Current (Source)	IOH5A	VDD = 5V, VOUT = 4.6V	1, 2	+125°C	-	-0.36	mA
				-55°C	-	-0.64	mA
Output Current (Source)	IOH5B	VDD = 5V, VOUT = 2.5V	1, 2	+125°C	-	-1.15	mA
				-55°C	-	-2.0	mA
Output Current (Source)	IOH10	VDD = 10V, VOUT = 9.5V	1, 2	+125°C	-	-0.9	mA
				-55°C	-	-1.6	mA
Output Current (Source)	IOH15	VDD = 15V, VOUT = 13.5V	1, 2	+125°C	-	-2.4	mA
				-55°C	-	-4.2	mA
Propagation Delay	TPHL TPLH	VDD = 10V	1, 2, 3	+25°C	-	140	ns
		VDD = 15V	1, 2, 3	+25°C	-	120	ns
Transition Time	TTHL TTLH	VDD = 10V	1, 2, 3	+25°C	-	100	ns
		VDD = 15V	1, 2, 3	+25°C	-	80	ns

Specifications CD40106BMS

TABLE 3. ELECTRICAL PERFORMANCE CHARACTERISTICS (Continued)

PARAMETER	SYMBOL	CONDITIONS	NOTES	TEMPERATURE	LIMITS		UNITS
					MIN	MAX	
Input Capacitance	CIN	Any Input	1, 2	+25°C	-	7.5	pF

NOTES:

1. All voltages referenced to device GND.
2. The parameters listed on Table 3 are controlled via design or process and are not directly tested. These parameters are characterized on initial design release and upon design changes which would affect these characteristics.
3. CL = 50pF, RL = 200K., Input TR, TF < 20ns

TABLE 4. POST IRRADIATION ELECTRICAL PERFORMANCE CHARACTERISTICS

PARAMETER	SYMBOL	CONDITIONS	NOTES	TEMPERATURE	LIMITS		UNITS
					MIN	MAX	
Supply Current	IDD	VDD = 20V, VIN = VDD or GND	1, 4	+25°C	-	7.5	μA
N Threshold Voltage	VNTH	VDD = 10V, ISS = -10μA	1, 4	+25°C	-2.8	-0.2	V
N Threshold Voltage Delta	ΔVTN	VDD = 10V, ISS = -10μA	1, 4	+25°C	-	±1	V
P Threshold Voltage	VTP	VSS = 0V, IDD = 10μA	1, 4	+25°C	0.2	2.8	V
P Threshold Voltage Delta	ΔVTP	VSS = 0V, IDD = 10μA	1, 4	+25°C	-	±1	V
Functional	F	VDD = 18V, VIN = VDD or GND VDD = 3V, VIN = VDD or GND	1	+25°C	VOH > VDD/2	VOL < VDD/2	V
Propagation Delay Time	TPHL TPLH	VDD = 5V	1, 2, 3, 4	+25°C	-	1.35 x +25°C Limit	ns

- NOTES: 1. All voltages referenced to device GND. 2. CL = 50pF, RL = 200K, Input TR, TF < 20ns. 3. See Table 2 for +25°C limit. 4. Read and Record

TABLE 5. BURN-IN AND LIFE TEST DELTA PARAMETERS +25°C

PARAMETER	SYMBOL	DELTA LIMIT
Supply Current - MSI-1	IDD	± 0.2μA
Output Current (Sink)	IOL5	± 20% x Pre-Test Reading
Output Current (Source)	IOH5A	± 20% x Pre-Test Reading

TABLE 6. APPLICABLE SUBGROUPS

CONFORMANCE GROUP	MIL-STD-883 METHOD	GROUP A SUBGROUPS	READ AND RECORD
Initial Test (Pre Burn-In)	100% 5004	1, 7, 9	IDD, IOL5, IOH5A
Interim Test 1 (Post Burn-In)	100% 5004	1, 7, 9	IDD, IOL5, IOH5A
Interim Test 2 (Post Burn-In)	100% 5004	1, 7, 9	IDD, IOL5, IOH5A
PDA (Note 1)	100% 5004	1, 7, 9, Deltas	
Interim Test 3 (Post Burn-In)	100% 5004	1, 7, 9	IDD, IOL5, IOH5A
PDA (Note 1)	100% 5004	1, 7, 9, Deltas	
Final Test	100% 5004	2, 3, 8A, 8B, 10, 11	
Group A	Sample 5005	1, 2, 3, 7, 8A, 8B, 9, 10, 11	

Specifications CD40106BMS

TABLE 6. APPLICABLE SUBGROUPS

CONFORMANCE GROUP		MIL-STD-883 METHOD	GROUP A SUBGROUPS	READ AND RECORD
Group B	Subgroup B-5	Sample 5005	1, 2, 3, 7, 8A, 8B, 9, 10, 11, Deltas	Subgroups 1, 2, 3, 9, 10, 11
	Subgroup B-6	Sample 5005	1, 7, 9	
Group D		Sample 5005	1, 2, 3, 8A, 8B, 9	Subgroups 1, 2, 3

NOTE: 1. 5% Parametric, 3% Functional; Cumulative for Static 1 and 2.

TABLE 7. TOTAL DOSE IRRADIATION

CONFORMANCE GROUPS	MIL-STD-883 METHOD	TEST		READ AND RECORD	
		PRE-IRRAD	POST-IRRAD	PRE-IRRAD	POST-IRRAD
Group E Subgroup 2	5005	1, 7, 9	Table 4	1, 9	Table 4

TABLE 8. BURN-IN AND IRRADIATION TEST CONNECTIONS

FUNCTION	OPEN	GROUND	VDD	9V ± 0.5V	OSCILLATOR	
					50kHz	25kHz
Static Burn-In 1 Note 1	2, 4, 6, 8, 10, 12	1, 3, 5, 7, 9, 11, 13	14			
Static Burn-In 2 Note 1	2, 4, 6, 8, 10, 12	7	1, 3, 5, 9, 11, 13, 14			
Dynamic Burn-In Note 1	-	7	14	2, 4, 6, 8, 10, 12	1, 3, 5, 9, 11, 13	
Irradiation Note 2	2, 4, 6, 8, 10, 12	7	1, 3, 5, 9, 11, 13, 14			

NOTES:

- Each pin except VDD and GND will have a series resistor of $10K \pm 5\%$, $VDD = 18V \pm 0.5V$
- Each pin except VDD and GND will have a series resistor of $47K \pm 5\%$; Group E, Subgroup 2, sample size is 4 dice/wafer, 0 failures, $VDD = 10V \pm 0.5V$

Typical Performance Characteristics

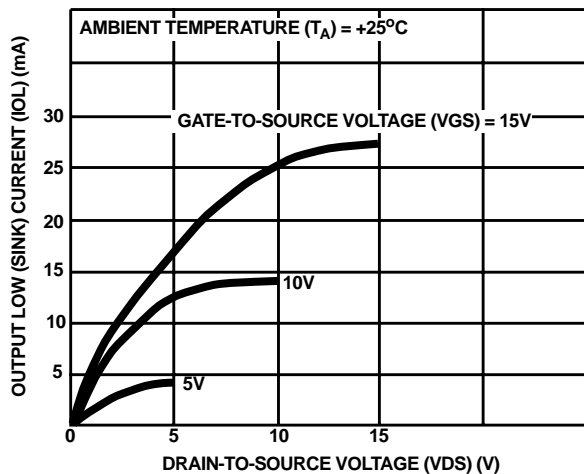

FIGURE 2. TYPICAL OUTPUT LOW (SINK) CURRENT CHARACTERISTICS

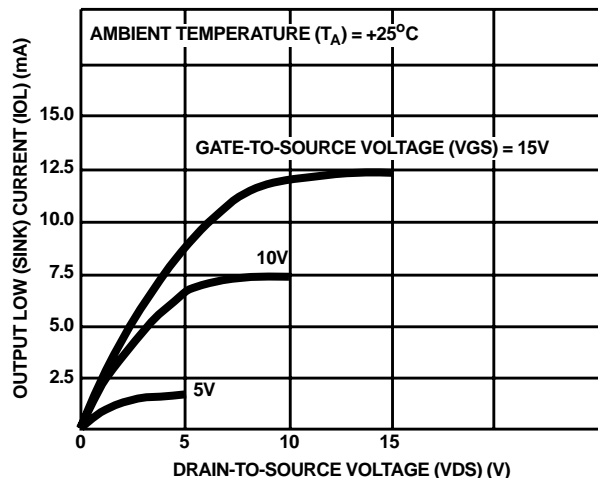

FIGURE 3. MINIMUM OUTPUT LOW (SINK) CURRENT CHARACTERISTICS

Typical Performance Characteristics (Continued)

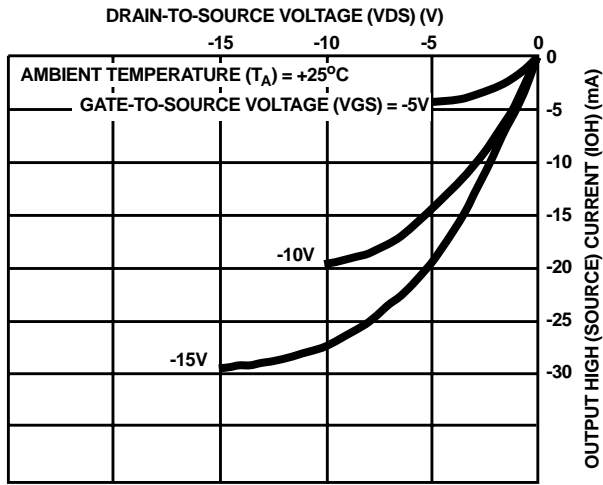

FIGURE 4. TYPICAL OUTPUT HIGH (SOURCE) CURRENT CHARACTERISTICS

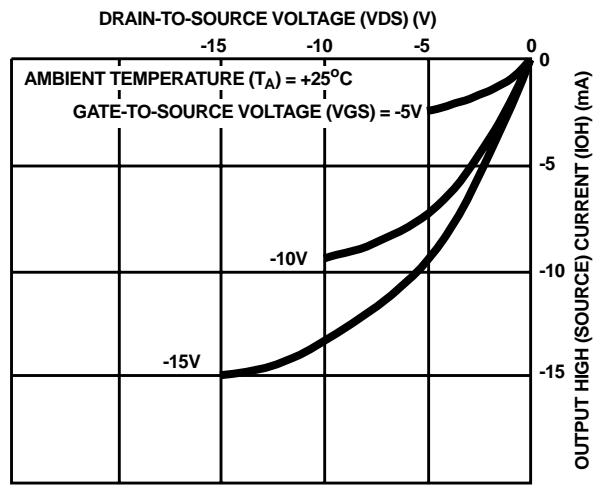

FIGURE 5. MINIMUM OUTPUT HIGH (SOURCE) CURRENT CHARACTERISTICS

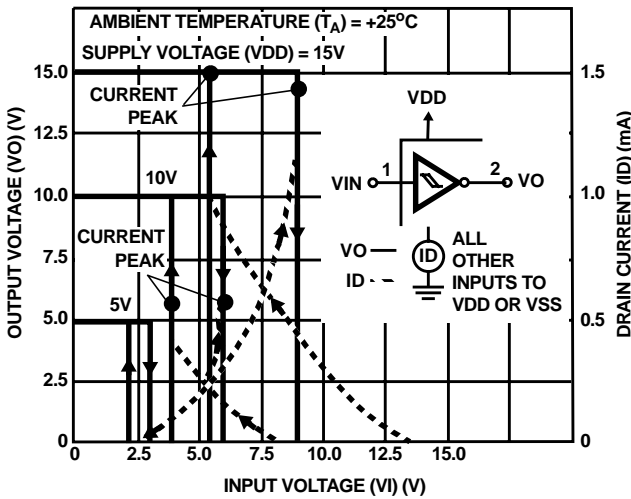

FIGURE 6. TYPICAL CURRENT AND VOLTAGE TRANSFER CHARACTERISTICS

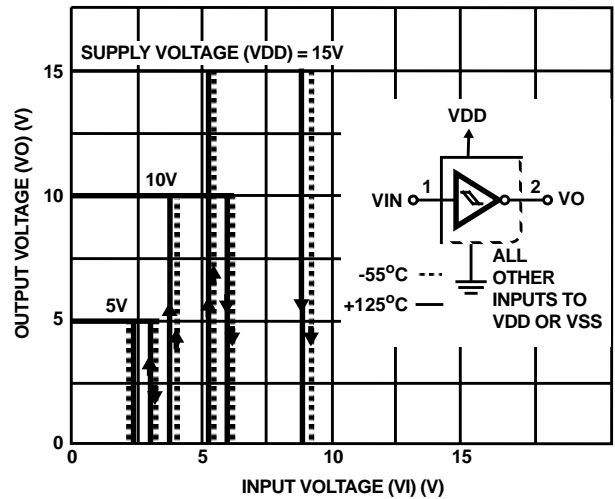

FIGURE 7. TYPICAL VOLTAGE TRANSFER CHARACTERISTICS AS A FUNCTION OF TEMPERATURE

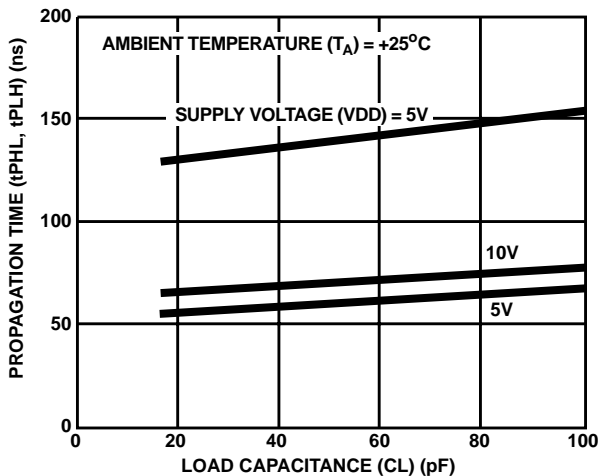

FIGURE 8. TYPICAL PROPAGATION DELAY TIME AS A FUNCTION OF LOAD CAPACITANCE

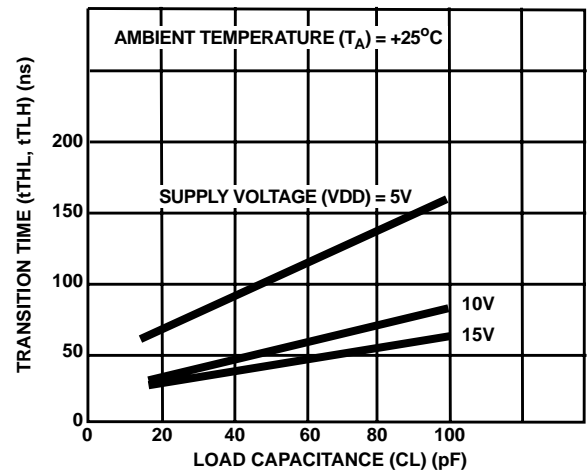

FIGURE 9. TYPICAL TRANSITION TIME AS A FUNCTION OF LOAD CAPACITANCE

Typical Performance Characteristics (Continued)

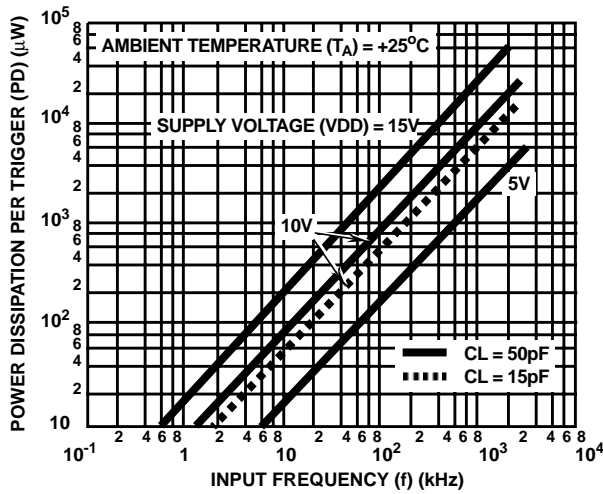

FIGURE 10. TYPICAL POWER DISSIPATION PER TRIGGER AS A FUNCTION OF INPUT FREQUENCY

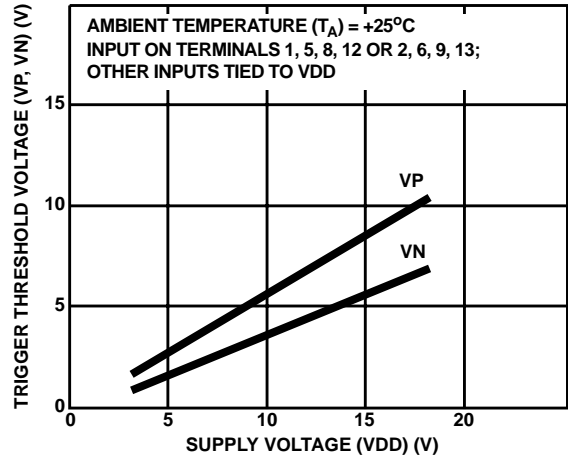

FIGURE 11. TYPICAL TRIGGER THRESHOLD VOLTAGE AS A FUNCTION OF SUPPLY VOLTAGE

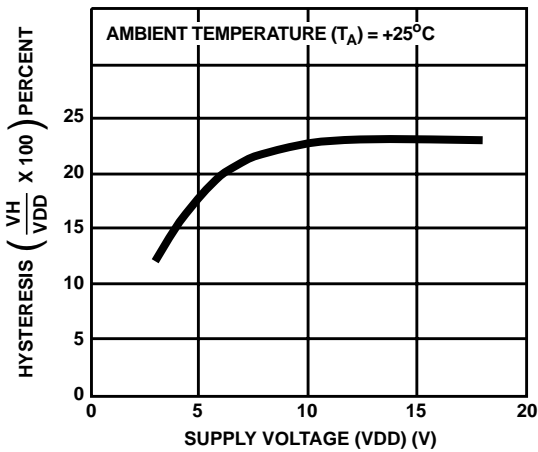

FIGURE 12. TYPICAL PERCENT HYSTERESIS AS A FUNCTION OF SUPPLY VOLTAGE

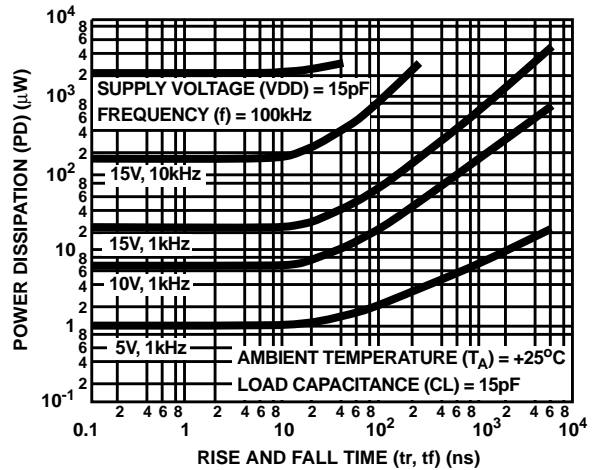

FIGURE 13. TYPICAL POWER DISSIPATION AS A FUNCTION OF RISE AND FALL TIMES

Applications

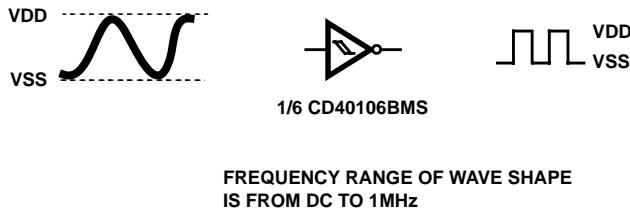

FIGURE 14. WAVE SHAPER

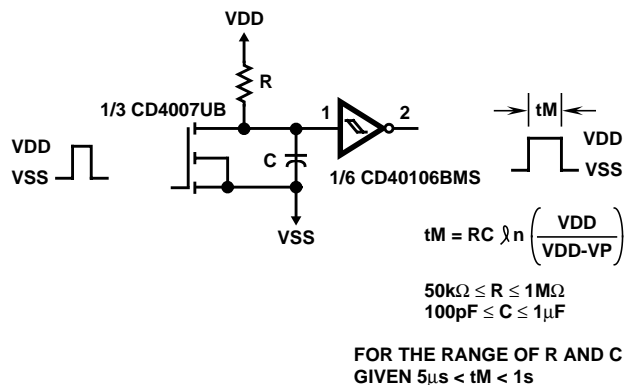

FIGURE 15. MONOSTABLE MULTIVIBRATOR

Applications (Continued)

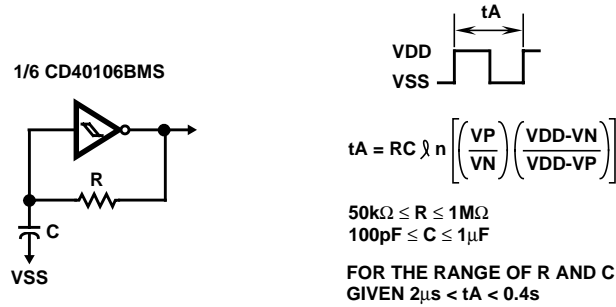

FIGURE 16. ASTABLE MULTIVIBRATOR

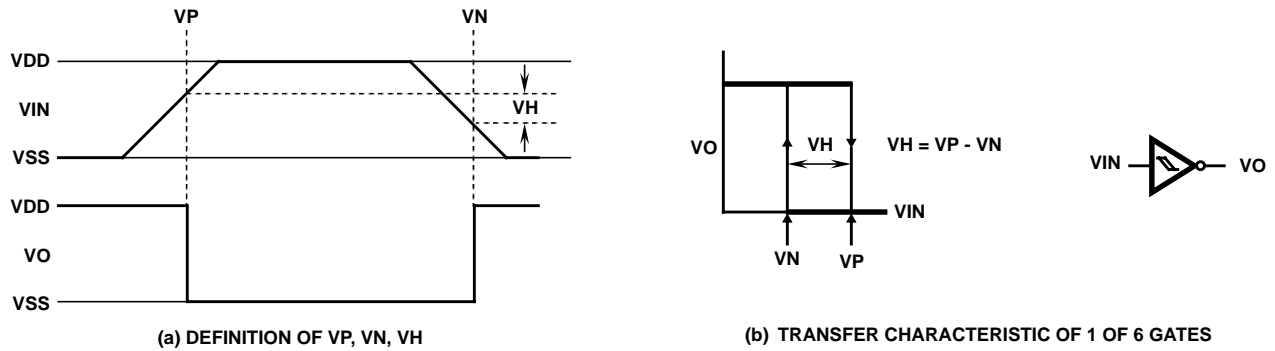

FIGURE 17. HYSTERESIS DEFINITION, CHARACTERISTICS, AND TEST SETUP

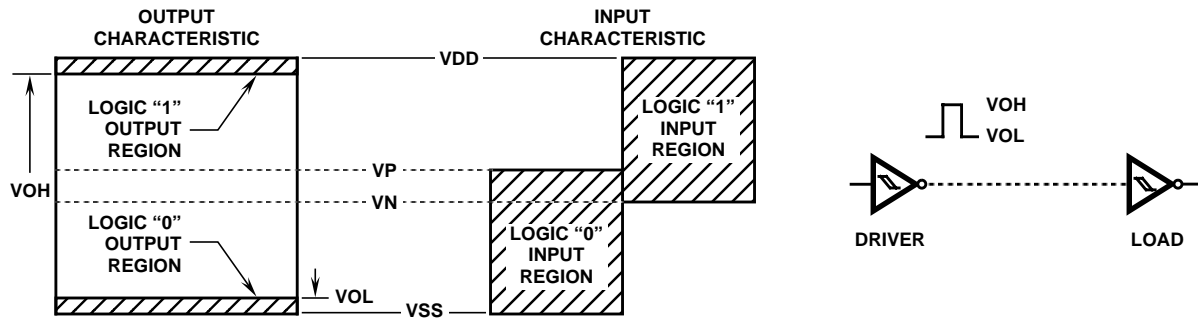
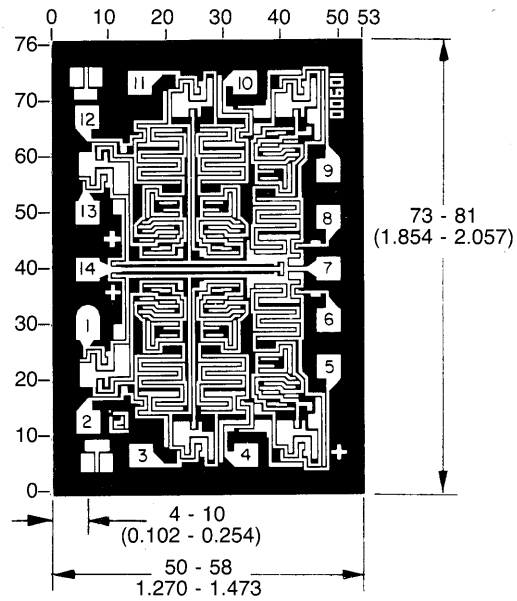

FIGURE 18. INPUT AND OUTPUT CHARACTERISTICS

CD40106BMS

Chip Dimensions and Pad Layout



Dimensions in parenthesis are in millimeters and are derived from the basic inch dimensions as indicated. Grid graduations are in mils (10^{-3} inch).

- METALLIZATION:** Thickness: $11\text{k}\text{\AA} - 14\text{k}\text{\AA}$, AL.
- PASSIVATION:** $10.4\text{k}\text{\AA} - 15.6\text{k}\text{\AA}$, Silane
- BOND PADS:** 0.004 inches X 0.004 inches MIN
- DIE THICKNESS:** 0.0198 inches - 0.0218 inches